

Lms43LED-CG



Device parameters	Symbol	Value	Units
Operating/storage temperature	T_{opr}	0..+50	$^{\circ}\text{C}$
Soldering temperature (time < 3 seconds, 3 mm from case)	T_{sol}	+180	$^{\circ}\text{C}$

All parameters are for LED operation at 25 $^{\circ}\text{C}$ unless otherwise stated.

LED parameters	Conditions	Symbol	Value	Units
Peak emission wavelength ¹	qCW mode ³ $I = 150 \text{ mA}$	λ_p	4.10 - 4.30	μm
FWHM of the emission band ¹	qCW mode ³ $I = 150 \text{ mA}$	FWHM	400 - 1200	nm
Average optical power (minimal / typical) ¹	qCW mode ³ $I = 200 \text{ mA}$	P_{qcw}	min 80 / typ 180	μW
Peak optical power (minimal / typical) ²	Pulse mode ⁴ $I = 1 \text{ A}$	P_{pul}	min 500 / typ 1500	μW
Maximum operating current	qCW mode ³	$I_{max\ qcw}$	250	mA
	Pulse mode ⁴	$I_{max\ pulse}$	2	A
Forward voltage ¹	qCW mode ³ $I = 200 \text{ mA}$	V	0.2 - 0.8	V

Typical spectrum (qCW³)

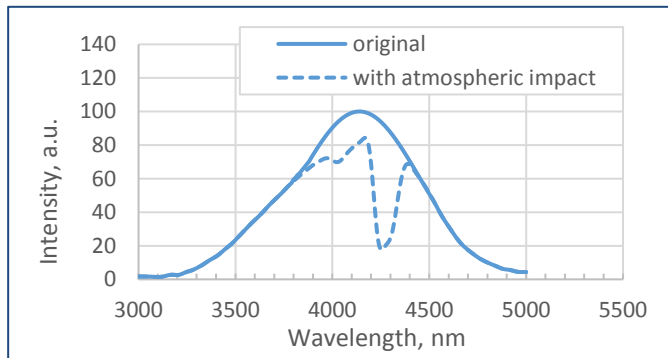

Typical optical power characteristic (qCW³)

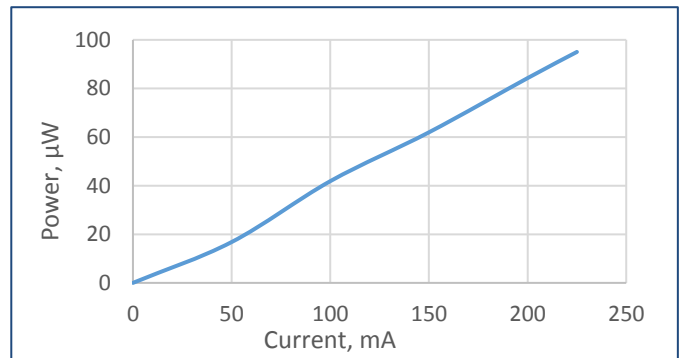

Typical current-voltage characteristic (qCW³)

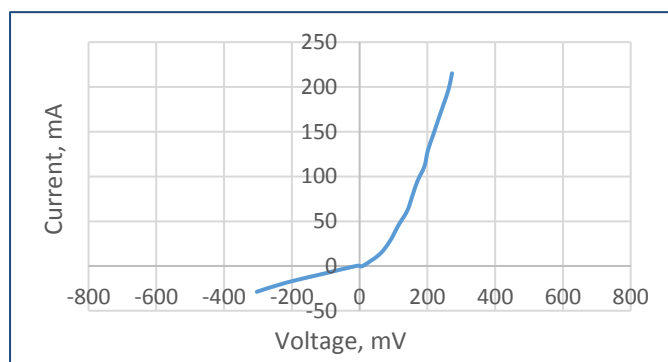

¹ Parameter tested for each device.

² Parameter tested for representative sampling.

³ qCW mode: repetition rate: 0.5 KHz, pulse duration: 1 ms, duty cycle: 50%.

⁴ Pulse mode: repetition rate: 0.5 KHz, pulse duration: 20 μs , duty cycle: 1%.

Packages	Model
TO-18 with glass cover	Lms43LED-CG

Radiant characteristic (far-field pattern)

TO-18 package with glass cover

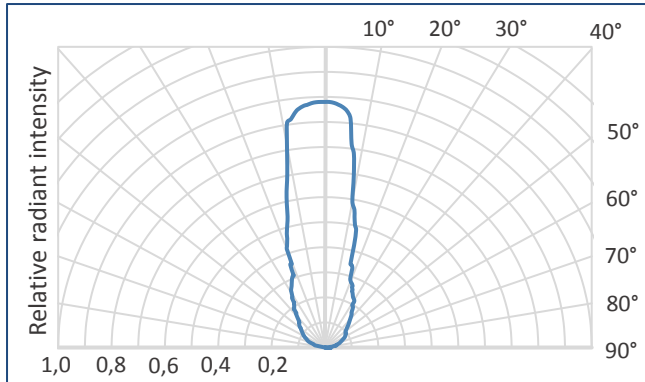

Related products:

- **Photodiodes Lms43PD, Lms49PD series** - detectors of mid-infrared radiation;
- **LED drivers (D-41i, D-51i, minidrivers mD-1c, mD-1p)** - provide LED power supply in pulse modes.

To drive the LED we recommend the following basic circuit connection:

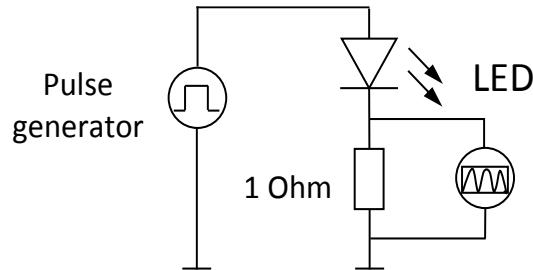

We recommend using **Quasi Continuous Wave (qCW) mode** with a duty cycle 50% or 25% to obtain maximum average optical power and short **Pulse modes** to obtain maximum peak power. Hard CW (continuous wave) mode is NOT recommended.

Quasi Continuous Wave (qCW) mode

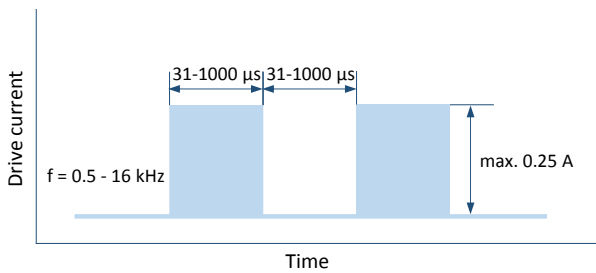

Pulse mode

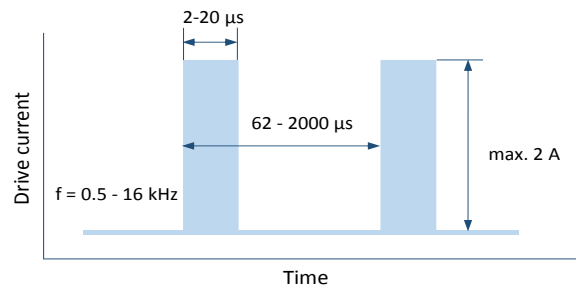

IMPORTANT CAUTIONS:

- please check your connection circuit before turning on the LED;
- please mind the LED polarity: anode is marked with a RED dot; REVERSE voltage applying is FORBIDDEN;
- please do not connect the LED to the multimeter;
- please control the CURRENT applied to the LED in order NOT to EXCEED the maximum allowable values;
- please do not touch glass covering and do not apply any force to it;
- please observe the operating and storage temperature, exceeding the allowable range may cause irreparable damage of glass covering.

Technical Drawing

Lms43LED-CG

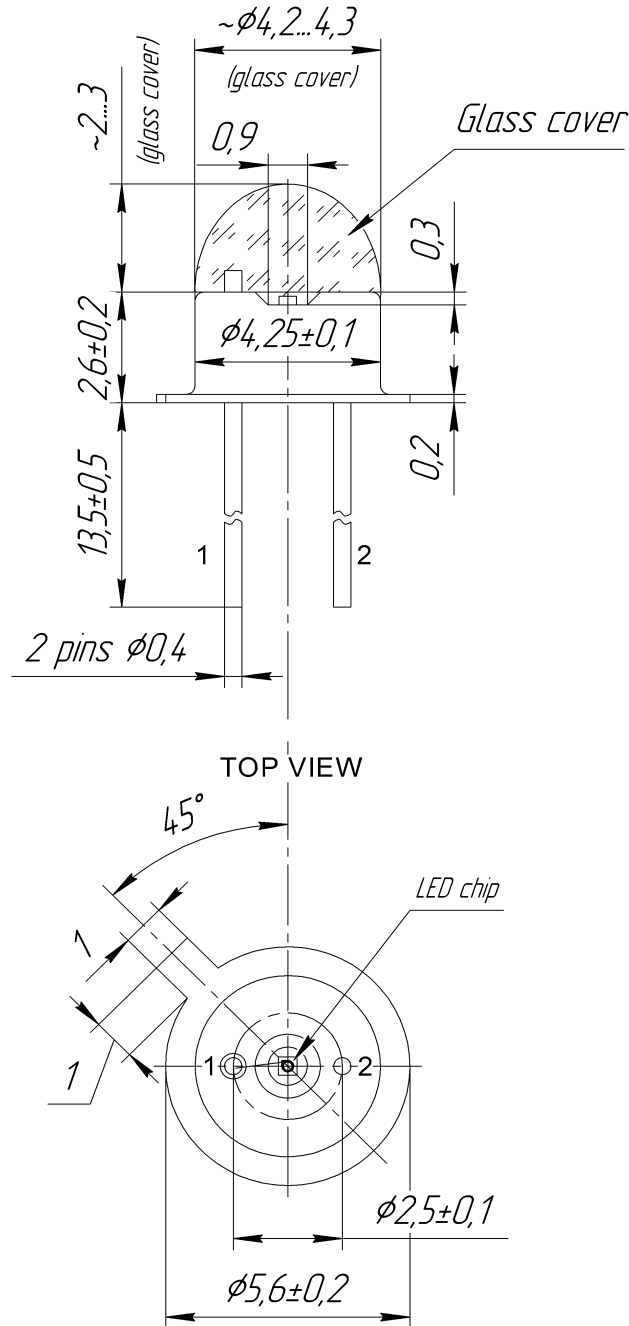

*NOTE: LED anode is marked with a RED dot.
All dimensions are pointed in mm.*