



TELEDYNE
JUDSON TECHNOLOGIES
Everywhereyoulook™

Mercury Cadmium Telluride Detectors

Teledyne Judson Technologies LLC

221 Commerce Drive
Montgomeryville, PA 18936 USA

Tel: 215-368-6900

Fax: 215-362-6107

Visit us on the web.

www.teledynejudson.com

General

HgCdTe is a ternary semiconductor compound which exhibits a wavelength cutoff proportional to the alloy composition. The actual detector is composed of a thin layer (10 to 20 μm) of HgCdTe with metalized contact pads defining the active area. Photons with energy greater than the semiconductor band-gap energy excite electrons into the conduction band, thereby increasing the conductivity of the material. The wavelength of peak response depends on the material's band-gap energy and can easily be varied by changing the alloy composition.

In order to sense the change in conductivity, a bias current or voltage is required. Typically, detectors are manufactured in a square or rectangular configuration to maintain a uniform bias current distribution throughout the active region.

Detector Bias and Operating Circuit

A basic circuit for operating J15 Series PC HgCdTe detectors is shown in Figure 26-2. These detectors are low impedance devices, typically 10 to 150 ohms, and require a low voltage noise preamplifier. A constant bias current is produced in the detector using a low noise DC voltage supply or battery with a current-limiting resistor R_B . An AC coupling capacitor blocks the DC bias voltage from the high gain preamplifier and prevents DC saturation.

For optimum performance, the model PA-101 preamp is recommended for most J15 Series detectors. The PA-101 has built-in bias circuitry and is specially matched to each detector at the factory. The PA-101's low noise, high gain and wide bandwidth ensure proper performance for subsequent signal processing with oscilloscopes, A-D converters, lock-in amplifiers, etc.

D^* and Responsivity vs. Bias

The responsivity and detectivity of all J15 Series HgCdTe detectors are a function of bias current. Figure 26-3 shows an example of relative responsivity and detectivity for a 1mm J15D14 Series LN_2 cooled detector. At low bias currents, the responsivity increases nearly linearly with bias. At high bias currents, self-heating of the detector eventually causes the responsivity to fall.

The point of maximum responsivity is generally not the recommended bias for the detector. System performance depends on the overall signal-to-noise ratio or detectivity. At low bias current the preamplifier noise or system noise may dominate. At high bias levels the $1/f$ surface noise often becomes unacceptably high. Each detector is supplied with a data sheet specifying the optimum bias current with the PA-101 preamp. The optimum bias may vary from application to application depending on background radiation levels.

Figure 26-1
 Schematic of HgCdTe PC Detector

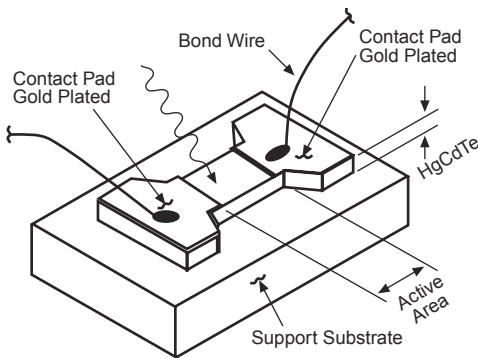

Figure 26-2
 Operating Circuit for J15 Series HgCdTe

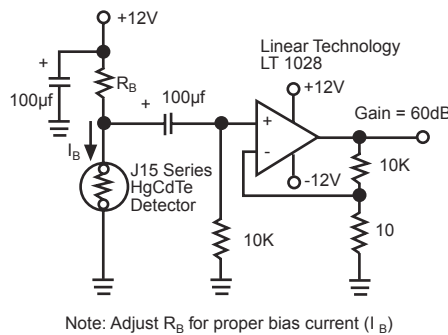
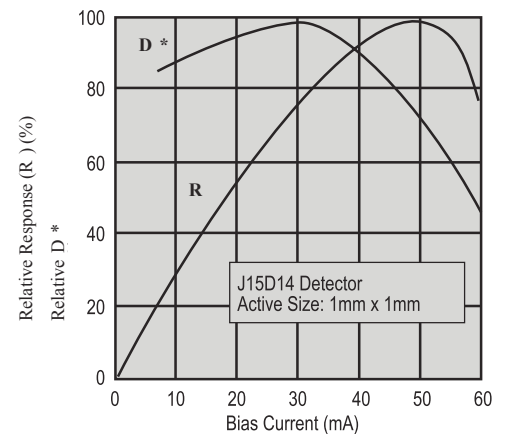

Figure 26-3
 Response and Detectivity vs Bias Current



Responsivity vs. Active Size

The voltage responsivity of all J15 Series HgCdTe PC detectors varies significantly with the active size of the element as shown in Fig. 27-1. Responsivity also depends on cutoff wavelength, field of view restriction, operating temperature and bias current. Responsivity for even "identical" detectors may range over a factor of 2 due to variations in material composition. The actual peak and blackbody responsivity data at optimum bias are supplied with each detector.

As with all photon detectors, the optimum system performance is achieved with the smallest size detector capable of collecting the available incident radiation. Focusing optics are highly recommended for reducing radiation spot sizes and thereby improving signal-to-noise performance.

Figure 27-1
 Typical Responsivity for J15 Series HgCdTe

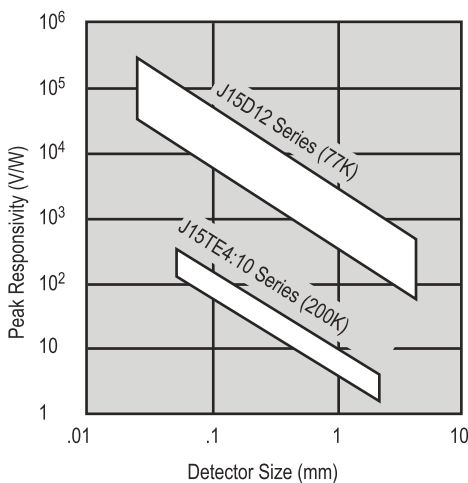

Responsivity and Noise vs. Frequency

The frequency response of HgCdTe detectors is related to the lifetime t of the electrons in the HgCdTe crystal, and t depends on material composition and operating temperature. Figure 27-2 is an example of responsivity and noise vs. frequency for a J15D12 Series LN₂ cooled detector. The actual time constant for each detector type can be found in the specification tables. The 3dB cutoff frequency f_c is given by $f_c = (2\pi t)^{-1}$.

All HgCdTe PC detectors exhibit excess low frequency noise which increases approximately as $f^{-1/2}$ below a certain "corner" frequency (typically 1KHz). The optimum detectivity is achieved over a wide range from the corner frequency up to the cutoff frequency f_c . The actual responsivity, noise and detectivity data at 10KHz are supplied with each detector.

Figure 27-2
 Example of Responsivity and Noise vs Frequency

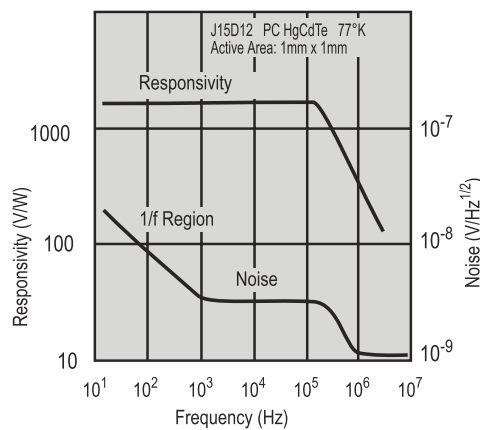

Linearity and Temperature Effects

Each J15 Series HgCdTe is specifically designed for a particular operating temperature range. Responsivity and detectivity will generally increase with decreasing temperature.

HgCdTe PC detectors have a wide dynamic range (see Fig. 27-4). However, a reduction in responsivity may occur at very high incident power levels.

Figure 27-3
 Detectivity vs Temperature for J15TE Series HgCdTe

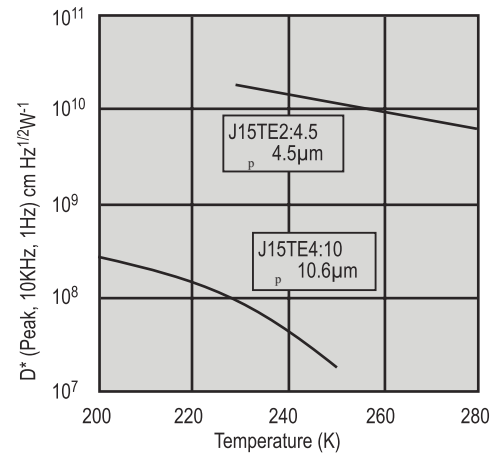
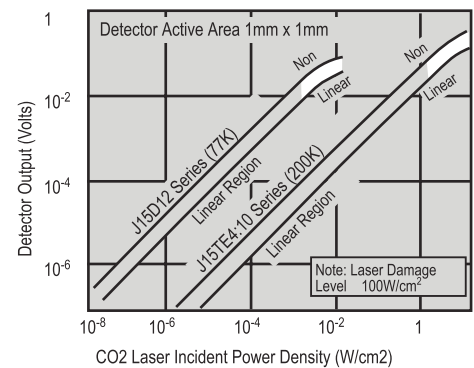

Figure 27-4
 Linearity Limitation @ 10.6μm for J15 Series HgCdTe



Description

The J15D Series detectors are Mercury Cadmium Telluride (HgCdTe) photoconductive (PC) detectors designed for operation in the 2 to 26 μm wavelength region. The wavelength of peak response depends on the specific alloy composition used.

All J15D Series detectors are designed for cryogenic operation at 77°K. Teledyne Judson's superior technology and careful device selection can provide background limited (BLIP) detectors with state-of-the-art performance

Applications

- Thermal Imaging
- CO₂ Laser Detection
- FTIR Spectroscopy
- Missile Guidance
- Night Vision

Figure 28-1
Example of Detectivity for J15D Series HgCdTe

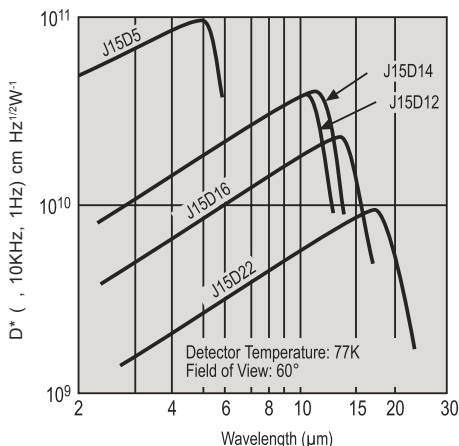

J15D5 Series HgCdTe PC Detectors (2 to 5 μm)

The J15D5 Series HgCdTe detectors peak at 5 μm and are recommended for thermal imaging or infrared tracking applications which require liquid nitrogen cooled PC detectors.

Excellent performance in the 3 to 5 μm wavelength region can also be obtained from our J15TE2, J15TE3 and J15TE4 Series thermoelectrically cooled HgCdTe detectors.

J15D12 Series HgCdTe PC Detectors (2 to 12 μm)

The J15D12 Series HgCdTe detectors peak at 11 μm with a cutoff wavelength greater than 12 μm . The devices offer optimum performance in the 8 to 12 μm wavelength region with high responsivity, near-BLIP performance and fast response time. Applications include thermography, CO₂ laser detection and missile guidance.

Minimum and typical detectivities for all standard sizes with a 60° FOV cold stop are listed in the adjoining specification table. Cold stops for reduced FOV's may improve detectivity since detector performance is often background limited. Custom cold filters may also improve detectivity by eliminating radiation in unwanted wavelength regions.

The detector is mounted in the M204 or the M205 metal dewar with ZnSe window. A wide variety of glass and metal dewar options are available, including dewars for Joule-Thomson cryostat and closed-cycle cooling. The J508 and RC2 cooler systems allow for operation of J15D12 detectors without bulk liquid nitrogen.

All Teledyne Judson HgCdTe PC detectors are fully passivated and can be provided on a dewar mount or a miniature flat pack for mounting by the customer.

The J15D12 Series detectors can be manufactured in a wide variety of special configurations including linear arrays, quad cells and two-color sandwich devices.



J15Dxx Series HgCdTe PC Detectors for FTIR Spectroscopy (2 to 26 μm)

The J15D14, J15D16, J15D22 and J15D24 Series HgCdTe detectors are specifically designed for use in conventional or Fourier Transform Infrared (FTIR) Spectroscopy. The J15D14 series offers the highest sensitivity for "narrow band" use (750 to 5000 cm^{-1}). The 1 mm active size is recommended for conventional sampling, and the 0.1 and 0.25 mm active sizes are best for microscope applications.

The J15D16 Series offers extended wavelength coverage for "midband" applications (600 to 5000 cm^{-1}) while still maintaining excellent detectivity.

The J15D22 Series or J15D24 Series are the detectors of choice for general "wide band" spectroscopy (425 to 5000 cm^{-1}). They have much higher sensitivity and speed than alternative pyroelectric devices.

J15D Series detectors are mounted in the standard M204 or M205 metal dewars. A variety of alternative dewars designed to fit most FTIR manufacturers' instruments are available as options.

Standard window materials for FTIR detectors are ZnSe for narrow band and midband, and KRS-5 for wide band. All windows have "wedged" surfaces to prevent unwanted interference effects. Detectivity performance data and a spectral response curve are provided with each detector.

Typical Specifications J15D Series HgCdTe @ 77°K, 60°FOV

Model Number	Part No.	Active Size (square) (mm)	Cutoff Wavelength co (20%) (μm)	Peak Wavelength peak (μm)	Peak D* @ 10KHz (cm Hz ^{1/2} W ⁻¹)		Typical Responsivity @ peak (V/W)	Time Constant (μsec)	Typical Resistance R _{DET} (/sq)	Typical Bias Current I _B (mA)	Packages	
					Min.	Typ.					Standard	Options
J15D5 Series HgCdTe (2-5 μm)												
J15D5-M204-S050U-60		0.05	~5.5	~5	8x10 ¹⁰	1x10 ¹¹	2x10 ⁵	1	100 to	~0.8	M204	See Catalog
J15D5-M204-S01M-60	450546	1			5x10 ¹⁰	8x10 ¹⁰	2x10 ³	5	800	~10		
J15D12 Series HgCdTe (2-12 μm)												
J15D12-M204-S025U-60	450059-1	0.025	>12	11±1	3x10 ¹⁰	5x10 ¹⁰	1x10 ⁵	0.15	20 to 120	~0.8	M204 Metal Sideview	See Catalog
J15D12-M204-S050U-60	450186-1	0.050			3x10 ¹⁰	5x10 ¹⁰	8x10 ⁴	0.2		~1.2		
J15D12-M204-S075U-60	450675	0.075			3x10 ¹⁰	5x10 ¹⁰	6x10 ⁴	0.3		~2		
J15D12-M204-S100U-60	450156-1	0.10			3x10 ¹⁰	5x10 ¹⁰	4x10 ⁴	0.4		~3		
J15D12-M204-S250U-60	450135-2	0.25			3x10 ¹⁰	5x10 ¹⁰	15x10 ³	0.5		~8		
J15D12-M204-S500U-60	450186-1	0.50			3x10 ¹⁰	4x10 ¹⁰	6x10 ³	0.5		~16		
J15D12-M204-S01M-60	450005-1	1			3x10 ¹⁰	4x10 ¹⁰	3x10 ³	0.5		~30		
J15D12-M204-S02M-60	450013-1	2			2x10 ¹⁰	2.5x10 ¹⁰	500	0.5		~40		
J15D12-M204-S04M-60	450022-1	4			1x10 ¹⁰	1.5x10 ¹⁰	100	0.5		~40		
J15Dxx Series HgCdTe for FTIR Spectroscopy (2-26 μm)												
J15D14-M204-S100U-60	450658	0.10	>13.5 (750cm ⁻¹)	~13	3x10 ¹⁰	5x10 ¹⁰	4x10 ⁴	0.5	20 to 100	~3	M204 Metal Sideview	See Catalog
J15D14-M204-S250U-60	450695	0.25			3x10 ¹⁰	5x10 ¹⁰	15x10 ³			~8		
J15D14-M204-S500U-60	451397	0.50			3x10 ¹⁰	4x10 ¹⁰	6x10 ³			~16		
J15D14-M204-S01M-60	450011-1	1			3x10 ¹⁰	4x10 ¹⁰	1x10 ³			~30		
J15D14-M204-S02M-60	450058-1	2			2x10 ¹⁰	2.5x10 ¹⁰	500			~40		
J15D16-M204-S100U-60	450761	0.10	~16.6 (600cm ⁻¹)	~14	2.5x10 ¹⁰	4x10 ¹⁰	9x10 ³	0.3	18 to 120	~3	M204 Metal Sideview	See Catalog
J15D16-M204-S250U-60	450951	0.25			2.5x10 ¹⁰	4x10 ¹⁰	3x10 ³			~8		
J15D16-M204-S01M-60	450624	1			2.5x10 ¹⁰	3x10 ¹⁰	900			~30		
J15D16-M204-S02M-60	450704	2			1.5x10 ¹⁰	2x10 ¹⁰	150			~40		
J15D22-M204-S250U-60	450869	0.25	~22 (450cm ⁻¹)	~16	5x10 ⁹	1x10 ¹⁰	800	0.1	18 to 120	~15	M204 Metal Sideview	See Catalog
J15D22-M204-S01M-60	450054-1	1			5x10 ⁹	1x10 ¹⁰	150			~40		
J15D22-M204-S02M-60	450283	2			4x10 ⁹	6x10 ⁹	30			~50		
J15D24-M204-S01M-60	450094-1	1	~24	~20	3x10 ⁹	5x10 ⁹	40	0.1	20-80	~40		
J15D26-M204-S01M-60	450554	1	~26	~20	2.5x10 ⁹	4x10 ⁹	30	0.08	20-80	~40		

J15TE Short Wave Mercury Cadmium Telluride Detectors (2 to 5 μm)

General

J15TE Series "Short-Wave" detectors are photoconductive HgCdTe elements on thermoelectric coolers. They are designed for industrial and military applications that require good sensitivity in the 2 to 5 μm wavelength region without liquid nitrogen cooling.

J15TE Series HgCdTe detectors offer significant advantages when compared to PbSe detectors, including high detectivity, low bias voltage, selective peak wavelength response, and fast response times.

J15TE2 Series 2-Stage Thermoelectrically Cooled HgCdTe Detectors

J15TE2 Series detectors include a high-quality HgCdTe element, a two-stage thermoelectric cooler, and a thermistor; hermetically sealed in a TO-style package (66C, 3CN or HS1).

The detector cutoff and peak response wavelengths vary depending on the selected HgCdTe material composition. Standard cutoff wavelengths for J15TE2 Series devices are 4.0 μm , 4.5 μm and 5.0 μm .

The 2-Stage Cooler

The two-stage thermoelectric cooler operates on low-voltage DC current to provide detector temperatures as low as -40°C (Fig. 31-1). The built-in thermistor can be used to monitor or control the detector temperature.

Teledyne Judson TE cooler power supplies and temperature controllers are recommended for convenient operation of the cooler.

Figure 30-2
Thermistor Curve (Typical)

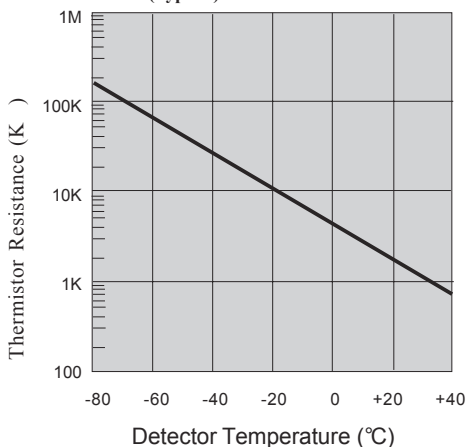

J15TE3:5 Series 3-Stage Thermoelectrically Cooled HgCdTe Detectors

J15TE3:5 Series detectors include a high-quality HgCdTe element, a three-stage thermoelectric cooler, and a thermistor; hermetically sealed with dry nitrogen in the flanged, "66C" package.

The detector is designed for optimum performance at 1 to 5 μm without the expense of four-stage TE or liquid nitrogen cooling.

The 3-Stage Cooler

The three-stage thermoelectric cooler operates on low-voltage DC current to provide detector temperatures as low as -65°C (Fig. 31-2). The built-in thermistor can be used to monitor or control the detector temperature.

Teledyne Judson TE cooler power supplies are fully passivated and can be provided on a dewar mount or a miniature flat pack for mounting by the customer.

The 4-Stage Cooler

The four-stage thermoelectric cooler operates on low-voltage DC current to provide detector temperatures as low as -80°C (Fig. 31-3). The built-in thermistor can be used to monitor or control the detector temperature.

Teledyne Judson TE cooler power supplies and temperature controllers are recommended for convenient operation of the cooler.

Figure 30-1
Typical Detectivity vs Wavelength for J15TE Series
Short-Wave HgCdTe Detectors

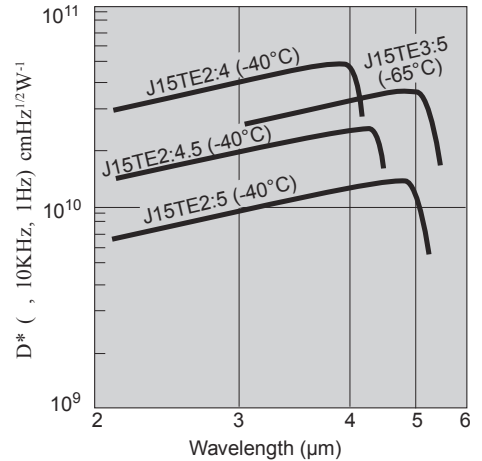

Thermoelectric Cooler Operation

Figures 31-1, 31-2 and 31-3 show typical TE2, TE3 and TE4 cooler power requirements. The Teledyne Judson CM21 assembly is recommended for optimal cooling and temperature control.

The HS1 package option provides a convenient heat sink for two-stage TE cooled detectors.

Heat sinks, hybrid amplifiers and temperature controllers for the TE coolers are also available.

Preamplifiers

The recommended preamplifiers for both the TE2 and TE3 Series detectors are Teledyne Judson's Model PA-101 and PA-300 voltage-mode preamps. The PA-101 provides constant bias current and signal amplification for 5Hz to 1MHz operation. The PA-300 provides constant bias voltage and signal amplification for DC to 1MHz operation.

Applications

- Thermal Imaging
- Industrial Process Control
- Heat-Seeking Guidance
- Laser Warning Receiver
- Laser Monitoring
- Temperature Monitoring

Typical Specifications J15TE Series Thermoelectrically Cooled HgCdTe

Model Number	Part No.	Active Size (square) (mm)	Oper. Temp. (°C)	Cutoff Wavelength λ_{co} (50%) (μm)	Peak Wavelength λ_{peak} (μm)	Minimum Blackbody D^* (500°K, 10KHz) ($\text{cmHz}^{1/2}\text{W}^{-1}$)	Typical Peak D^* (λ_{peak} , 10KHz) ($\text{cmHz}^{1/2}\text{W}^{-1}$)	Typical Responsivity @ λ_{peak} (V/W)	Time Constant τ (μsec)	Typical Bias Current I_B (mA)	Packages	
											Std.	Options
J15TE2 Series Two-Stage Thermoelectrically Cooled HgCdTe												
J15TE2:4-66C-S250U		.25	-40°C	4.0 ± 0.25	~4	1.8x10 ⁹	4x10 ¹⁰	16K	5	0.5 to 5	66C	HS1 and CM21
J15TE2:4-66C-S01M	450699	1		4.5 ± 0.25	~4.4	1.8x10 ⁹	2.5x10 ¹⁰	4K				
J15TE2:4.5-66C-S250U	450825	.25		4.5 ± 0.25	~4.4	1.8x10 ⁹	2.5x10 ¹⁰	8K	3			
J15TE2:4.5-66C-S01M	450082	1		4.5 ± 0.25	~4.4	1.8x10 ⁹	2.5x10 ¹⁰	2K				
J15TE2:5-66C-S250U	450673	.25		5.0 ± 0.25	~4.8	1.3x10 ⁹	1.5x10 ¹⁰	4K	2			
J15TE2:5-66C-S01M	450694	1		5.0 ± 0.25	~4.8	1.3x10 ⁹	1.5x10 ¹⁰	1K				
J15TE3:5 Series Three-Stage Thermoelectrically Cooled HgCdTe												
J15TE3:5-66C-S100U	450562	.10	-65°C	>5.0	~4.8	3.5x10 ⁹	3x10 ¹⁰	20K	2	0.5 to 5	66C	HS1 and CM21
J15TE3:5-66C-S250U	450674	.25						10K				
J15TE3:5-66C-S01M	450651	1						3K				
J15TE4 Series Four-Stage Thermoelectrically Cooled HgCdTe												
J15TE4:5-3CN-S100U	450645	.10	-80°C	>5.0	~4.8	6.0x10 ⁹	6.0x10 ¹⁰	40K	2	0.5 to 5	3CN	HS1 and CM21
J15TE4:5-3CN-S250U	450646	.25						10K				
J15TE4:5-3CN-S01M	450838	1						3K				

3CN Package

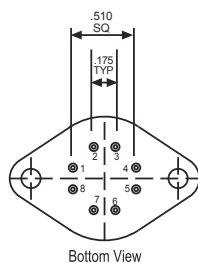
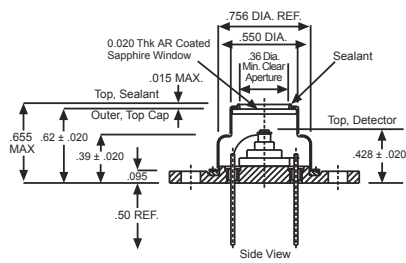

Pin No.	Designation	Sleeve Color
1	Thermistor	Yellow
2	Detector (-)	White
3	Detector (+)	Green
4	Cooler (-)	Black
5	Cooler (+)	Red
6	N/C	Clear
7	N/C	Clear
8	Thermistor	Yellow

66S and 66Z Package

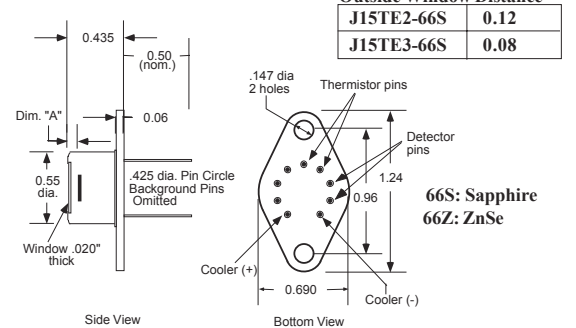

Figure 31-1 J15TE2 Detector Temperature vs TE2 Cooler Current

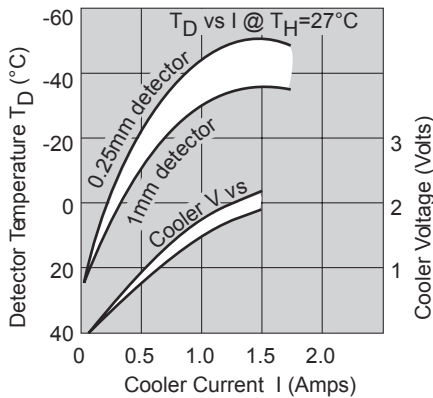

Figure 31-2 J15TE3:5-66S Detector Temperature vs TE3 Cooler Current

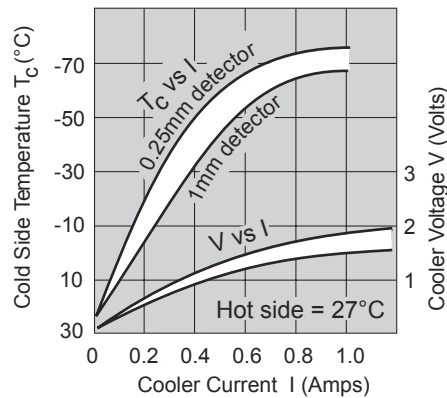
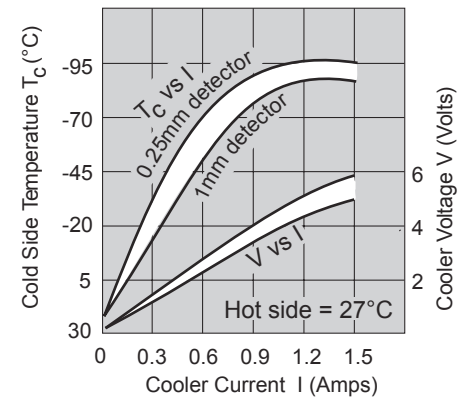

Figure 31-3 Detector Temperature vs TE4 Cooler Current



J15TE Long Wave Mercury Cadmium Telluride (10.6 μm)

General

J15TE Series "Long-Wave" detectors are photoconductive HgCdTe elements on thermoelectric coolers for CO₂ laser detection at 10.6μm or for FTIR Spectroscopy

The HgCdTe detectors offer significant advantages over alternative pyroelectric detectors, including low microphonics, immunity to EMI, and high detectivity over a broad range of frequencies (100Hz to 20MHz).

The J15TE3:10 detectors include an economical three-stage cooler, while the J15TE4 detectors are mounted on high-performance four-stage coolers.

Applications

- Laser Warning Receiver
- Laser Heterodyne Detector
- Laser Monitor
- FTIR Spectroscopy



**J15TE3:10 Series
3-Stage Thermoelectrically Cooled
HgCdTe Detectors**

A J15TE3:10 detector includes a high-quality HgCdTe element, a three-stage thermoelectric cooler, and a thermistor, all hermetically sealed inside the compact 66GE package. The package is flanged for convenient mounting on a heat sink.

The detectors are designed for economical detection of pulsed or modulated high-power CO₂ lasers.

The 3-Stage Cooler

The three-stage thermoelectric cooler operates on low-voltage DC current to provide detector temperatures as low as -60°C (Fig. 33-1). The built-in thermistor can be used to monitor or control the detector temperature.

The Teledyne Judson CM21 cooler heat sink and temperature controller is recommended for convenient operation of the cooler.

Preamplifiers

Teledyne Judson's voltage-mode preamplifiers are recommended for both the TE3 and TE4 Series detectors. The Teledyne Judson preamps provide detector bias as well as signal amplification. The PA-300 preamplifier is recommended for FTIR applications and supply a constant bias voltage to the detector.

J15TE4:10 Series 4-Stage Thermoelectrically Cooled HgCdTe Detectors

A J15TE4:10 detector includes a high-quality HgCdTe element, a four-stage thermoelectric cooler and a thermistor in the 3GN hermetic package.

The 3GN is a rugged package with welded seals to ensure superior hermetic integrity and long life.

The detectors are designed for pulsed or modulated CO₂ laser applications at 10.6 μm where the highest sensitivity possible without liquid nitrogen cooling is required.

J15TE4:FTIR Series

A J15TE4:FTIR detector includes a high quality HgCdTe element a four-stage thermoelectric cooler, and a thermistor in the 3GN hermetic package.

The detectors are designed to give maximum signal to noise ratios for wideband FTIR applications from 1.0 μm to the cutoff wavelength specified. In combination with the CM21 assembly and a PA-300 amplifier this series gives reliable 24 hour performance.

The 4-Stage Cooler

The four-stage thermoelectric cooler operates on low-voltage DC current to provide detector temperatures as low as 195°K (Fig. 33-2). The built-in thermistor can be used to monitor or control the detector temperature.

For optimum performance, the package should be mounted on a heat sink capable of dissipating 5 to 10 watts (Fig. 33-3).

The Teledyne Judson CM21 heat sink and temperature controller is recommended for convenient cooler operation.

TE4 Cooler Specifications:

- Number of Stages: 4
- Cooldown Time: 30 to 150 sec
- Min. Temp. @ 25°Ambient: -90°C
- Power Required @ 6V: 3 to 7 Watts
- Ambient Temp. Range: -55 to +60°C

Figure 32-1
Example of Detectivity vs Wavelength
J15TE3:10 and J15TE4:10 Series HgCdTe

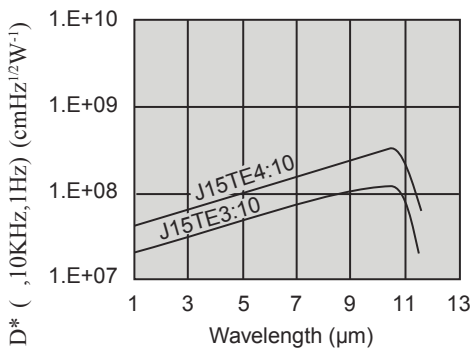

Typical Specifications **J15TE** Series Thermoelectrically Cooled HgCdTe

Model Number	Part No.	Active Size (square) (mm)	Operating Temperature (°C)	Peak Wavelength λ_{peak} (μm)	Peak D* @ 10KHz (cm Hz ^{1/2} W ⁻¹)		Typical Responsivity @ λ_{peak} (V/W)	Time Constant t (μsec)	Typical Bias Current I _B (V)	Packages	
					Min.	Typ.				Standard	Options
J15TE3:10 Series Three-Stage Thermoelectrically Cooled HgCdTe											
J15TE3:10-66GE-S250U	450660	0.25	-65	10.6μm	1x10 ⁸	2x10 ⁸	10	1	.175V	66GE	CM21, HS1
J15TE3:10-66GE-S01M	450632	1	-65	10.6μm	1x10 ⁸	2x10 ⁸	2	5	3V	66GE	CM21, HS1
J15TE4:10 Series Four-Stage Thermoelectrically Cooled HgCdTe											
J15TE4:10-3GN-S250U	451188	0.25	-80	10.6μm	3x10 ⁸	6x10 ⁸	20	1	.175V	3GN	CM21, HS1
J15TE4:10-3GN-S01M	450692	1	-80	10.6μm	3x10 ⁸	6x10 ⁸	5	5	3V	3GN	CM21, HS1

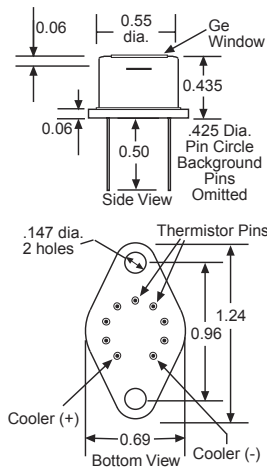
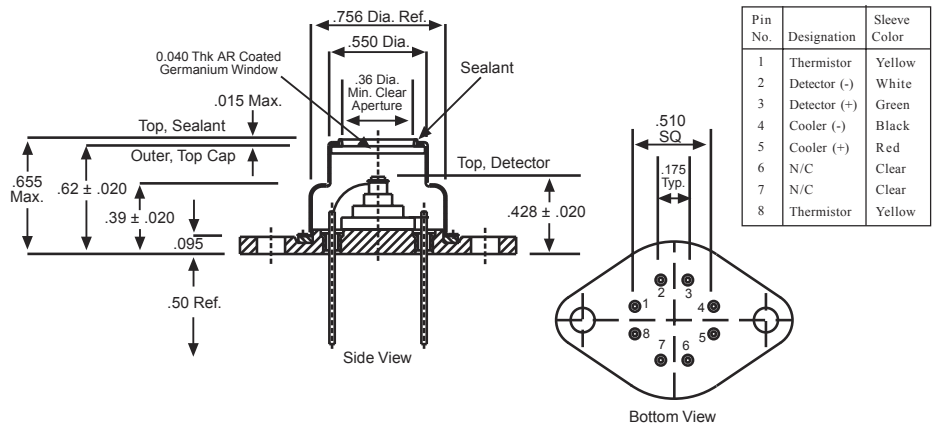
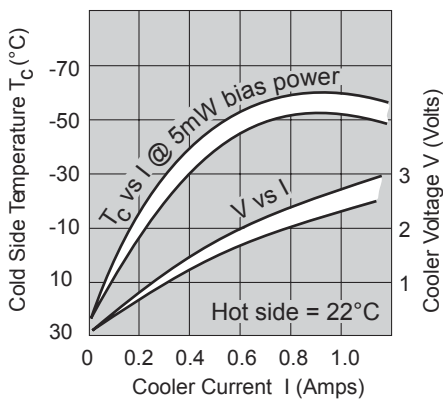
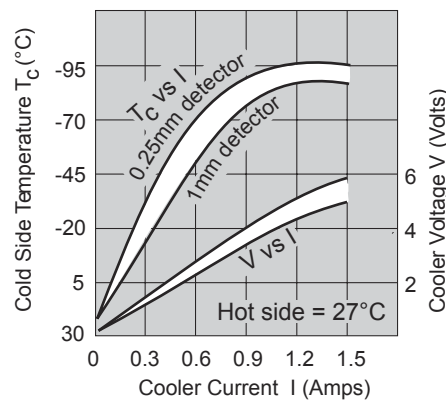
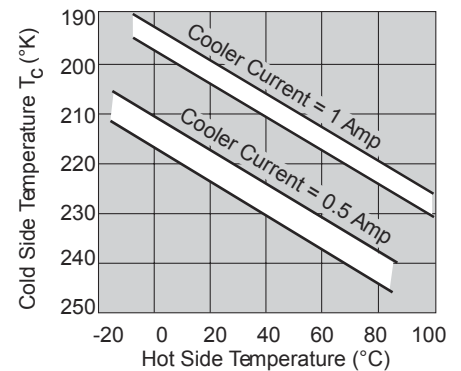
66GE Package

3GN Package

Figure 33-1
J15TE3:10 Three-stage Cooler Performance

Figure 33-2
J15TE4:XX Four-stage Cooler Performance

Figure 33-3
J15TE4:10 Four-stage Cooler Performance vs Heat Sink Temperature @ 40 mW Detector Bias

J15InSb HgCdTe/InSb Sandwich Detectors (1 to 13 μm)

Description

The J15InSb Series device consists of a high quality InSb detector mounted in a "sandwich" configuration over a HgCdTe detector.

The InSb detector responds to incident radiation from 1 to 5 μm , while the HgCdTe detector responds to radiation from 6 to 13 μm (Fig. 34-1). Devices with response to longer wavelengths are also available.

The detector focal planes are spaced within 0.5 mm and their centers are aligned to within 0.15 mm.

The detectors operate at 77°K and are mounted in the standard M204 or M205 metal dewar with ZnSe window.

The InSb and HgCdTe elements require separate preamplifiers.



Figure 34-1
Relative Response vs Wavelength
for J15InSb Series "Sandwich" Detector

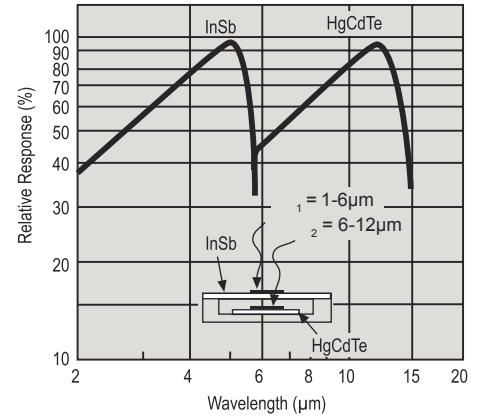

Typical Specifications J15InSb Series @77°K

Model Number	Part Number	Active Size (mm)	Wavelength Range (20% cutoff for HgCdTe) (μm)	Typical Peak Responsivity	Typical Peak D^* ($\lambda_{\text{peak}}, 10\text{KHz}$) ($\text{cmHz}^{1/2}\text{W}^{-1}$)	Dewar Packages	
						Standard	Options
J15InSb-M204-S01M-60	InSb HgCdTe 450662	1.0	1 to 5.5 6 to 12	2A/W 1500V/W	1×10^{11} 2.5×10^{10}	M204 Metal Sideview	Shown in Catalog
J15InSb-M204-S02M-60	InSb HgCdTe 450736	2.0	1 to 5.5 6 to 12	2A/W 500V/W	1×10^{11} 2×10^{10}		
J15D14InSb-M204-S01M-60	InSb HgCdTe 450107-1	1.0	1 to 5.5 6 to 13.5	2A/W 1000V/W	1×10^{11} 2×10^{10}		
J15D14InSb-M204-S02M-60	InSb HgCdTe 450052-2	2.0	1 to 5.5 6 to 13.5	2A/W 500V/W	1×10^{11} 2×10^{10}		
J15D16InSb-M204-S01M-60	InSb HgCdTe 450155	1.0	1 to 5.5 6 to 16.6	2A/W 500V/W	1×10^{11} 1×10^{10}		

Please consult factory for other sizes and wavelengths.

In addition to our Mercury Cadmium Telluride product line, Teledyne Judson Technologies offers a wide range of high performance standard, custom and space qualified detector products and accessories.

- Germanium detectors and arrays
- Indium Arsenide detectors and arrays
- Indium Antimonide detectors and arrays
- Lead Selenide detectors and arrays
- Lead Sulfide detectors and arrays
- Dewars, backfill and vacuum packages
- Thermoelectric, Joule Thomson and closed cycle linear and rotary coolers
- Preamplifiers
- Temperature controllers and readout electronics

Please contact us for more information on these products at 215-368-6900 or on the web at www.teledynejudson.com.



221 Commerce Drive
Montgomeryville, PA 18936 USA
Tel: 215-368-6900, Fax: 215-362-6107
www.teledynejudson.com
December, 2002